

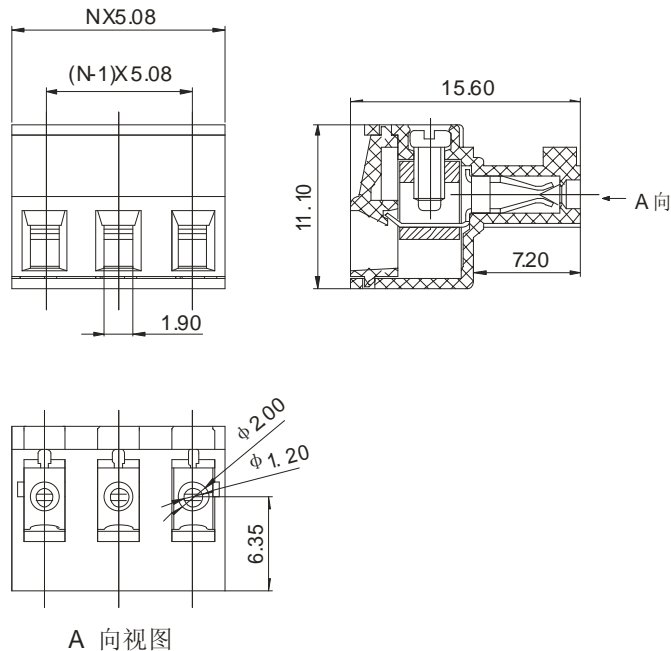





15EDGK-5.08

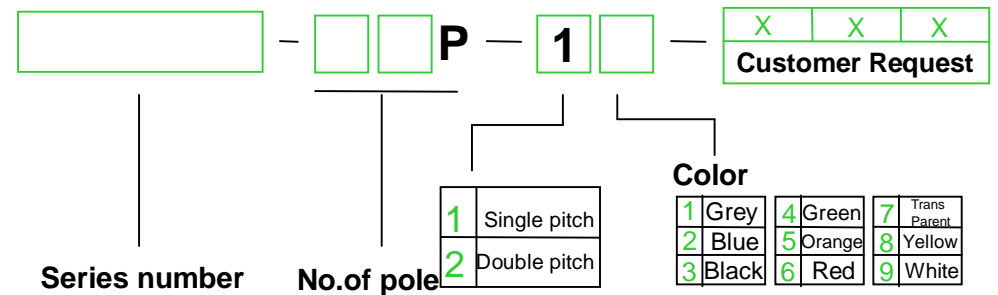

APPROVAL		
Electrical		
Standard	UL	IEC
Rated voltage	300V	250V
Rated current	8A	7A
Wire range	28-16AWG	0.5-1.5mm ²
Withstanding voltage	AC2000V/1Min	
Mechanical		
Torque	0.2Nm(1.7Lb-In)	
Ambient temperature	-40°C~+105 °C	
Strip length	7mm	
Dimensions		
Pitch	5.08mm(.200")	
Poles	2P-12P	
Material		
Housing	PA66,UL94 V-0	
Screws	M2,Steel,Cr ³⁺ Zn-plated	
Contact	Phosphor bronze	
Cage	Brass,Ni-plated	

HOW TO ORDER :

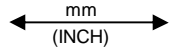

	 DEGSON ELECTRONICS CO., LTD.
	NAME 15EDGK-5.08