





APPROVAL Electrical		
Standard	UL	IEC
Rated voltage	300V	450V
Rated current	30A	32A
Wire range	26-10AWG	4.0mm ²
Withstanding voltage	AC2500V/1Min	
Menchanical		
Torque	0.5Nm(4.4Lb-In)	
Ambient temperature	-40°C~+105 °C	
Strip length	8-9mm	
Dimensions		
pitch	6.35mm(.250")	
Poles	2P,3P-24P	
Material		
Housing	PA66,UL94V-0	
Screws	M3,Steel, Cr ³⁺ Znplated	
Pin header	Copper,Tin-plated	
Cage	Brass,Ni-plated	



HOW TO ORDER :

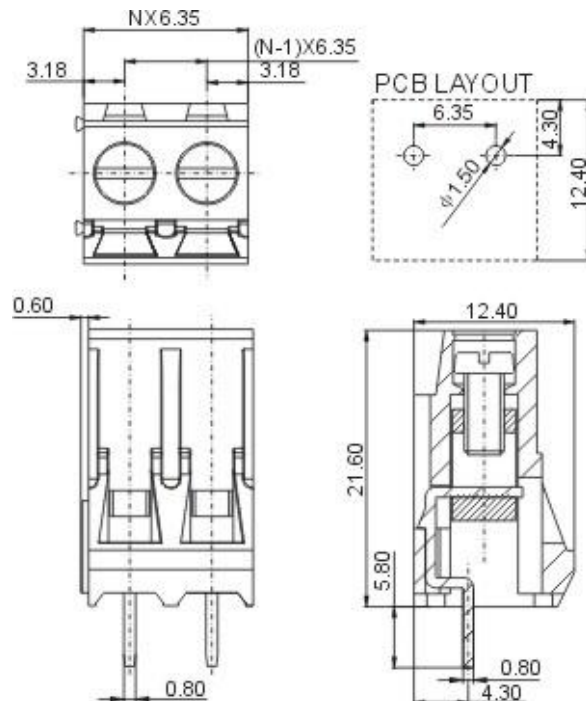
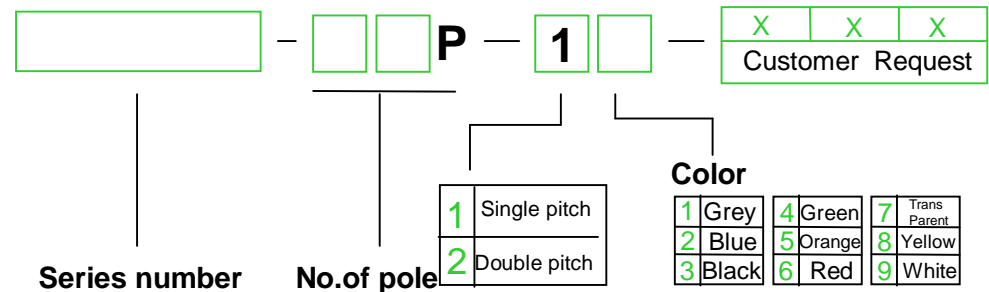
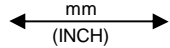

	 DEGSON ELECTRONICS CO., LTD.
	NAME DG635-6.35