

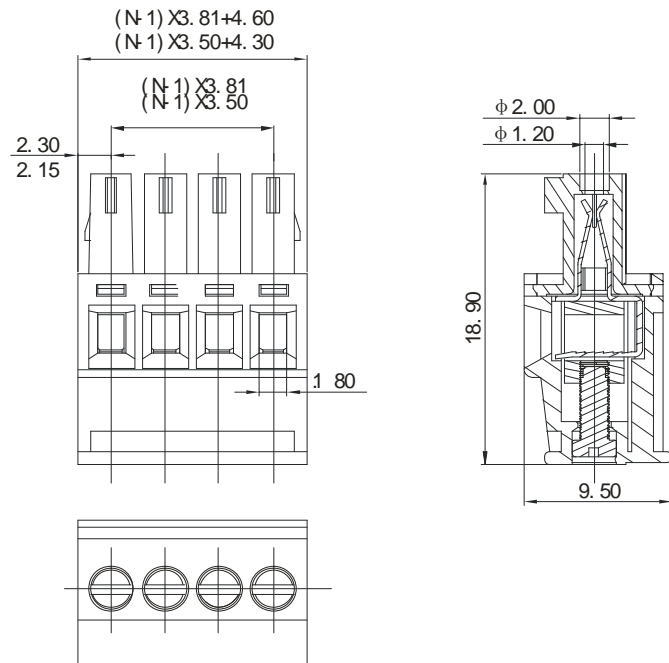





15EDGKA-3.5
15EDGKA-3.81

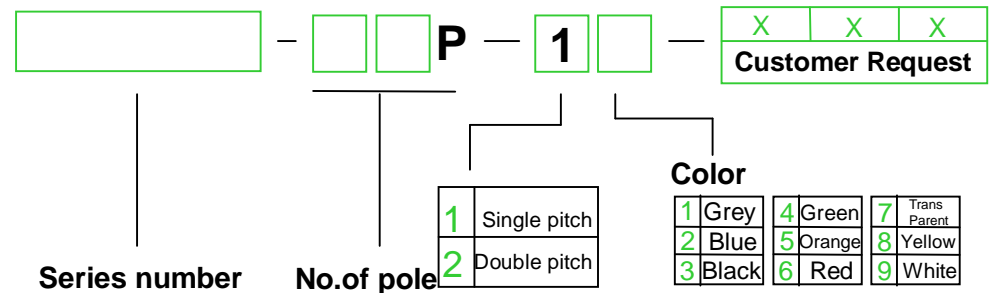

APPROVAL		
Electrical		
Standard	UL	IEC
Rated voltage	300V	250V
Rated current	8A	7A
Wire range	28-16AWG	0.5-1.5mm ²
Withstanding voltage	AC2000V/1Min	
Mechanical		
Torque	0.2Nm(1.7Lb-In)	
Ambient temperature	-30°C~+120 °C	
Strip length	7mm	
Dimensions		
Pitch	3.5mm(.138") 3.81mm(.150")	
Poles	2P-24P	
Material		
Housing	PBT,UL94V-0	
Screws	M2,Steel,Cr ³⁺ +Zn-plated	
Contact	Phosphor bronze	
Cage	Brass,Ni-plated	

HOW TO ORDER :

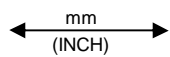

 mm (INCH)	 DEGSON ELECTRONICS CO., LTD.
 THROANGLE PROJECTION	NAME 15EDGKA-3.5, 15EDGKA-3.81