

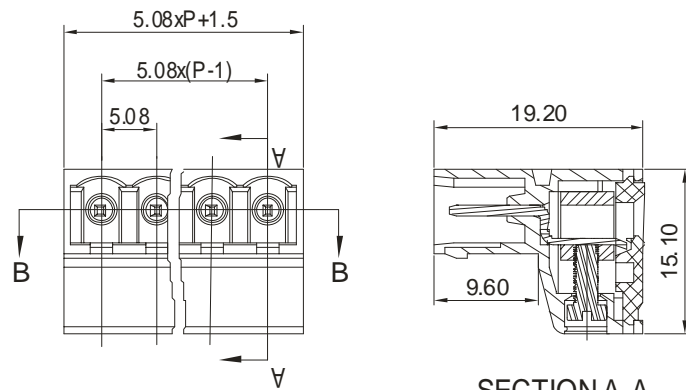





**2EDGKR-5.08**

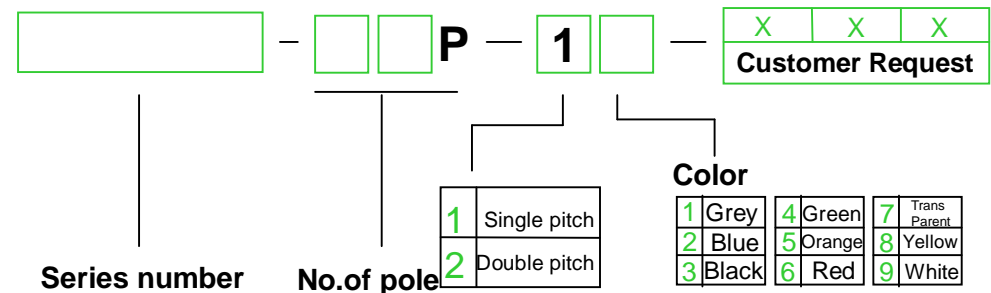

<b>APPROVAL</b>		
<b>Electrical</b>		
Standard	<b>UL</b>	<b>IEC</b>
Rated voltage	300V	320V
Rated current	15A	20A
Wire range	28-12AWG	2.5mm <sup>2</sup>
Withstanding voltage	AC2500V/1Min	
<b>Mechanical</b>		
Torque	0.4Nm(3.5Lb-In)	
Ambient temperature	-40°C~+105 °C	
Strip length	7mm	
<b>Dimensions</b>		
Pitch	5.08mm(.200" )	
Poles	2P-24P	
<b>Material</b>		
Housing	PA66,UL94 V-0	
Screws	M2.5,Steel,Cr <sup>3+</sup> Zn- plated	
Contact	Copper	
Cage	Brass,Ni-plated	

### HOW TO ORDER :

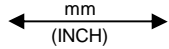

 mm (INCH)	 <b>DEGSON ELECTRONICS CO., LTD.</b>
 THROANGLE PROJECTION	<b>NAME</b> <b>2EDGKR-5.08</b>