





APPROVAL Electrical		
Standard	UL	IEC
Rated voltage	300V	250V
Rated current	15A	24A
Wire range	22-12AWG	2.5mm ²
Withstanding voltage	AC2000V/1Min	
Menchanical		
Torque	0.4Nm(3.5Lb-In)	
Ambient temperature	-40°C~+105 °C	
Strip length	7mm	
Dimensions		
pitch	5.0mm(.197")	
Poles	2P,3P-24P	
Material		
Housing	PA66,UL94V-0	
Screws	M2.5,Steel, Cr ³⁺ Znplated	
Pin header	Brass,Tin-plated	
Cage	Brass,Ni-plated	



HOW TO ORDER :

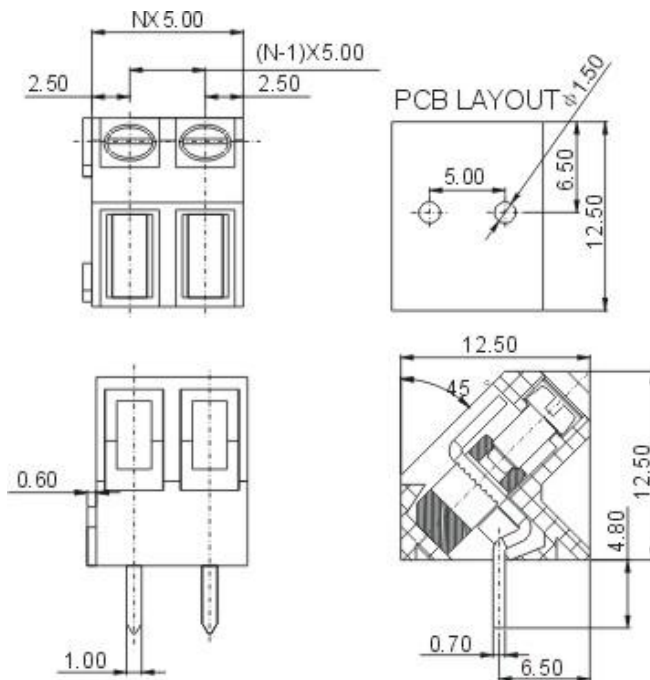
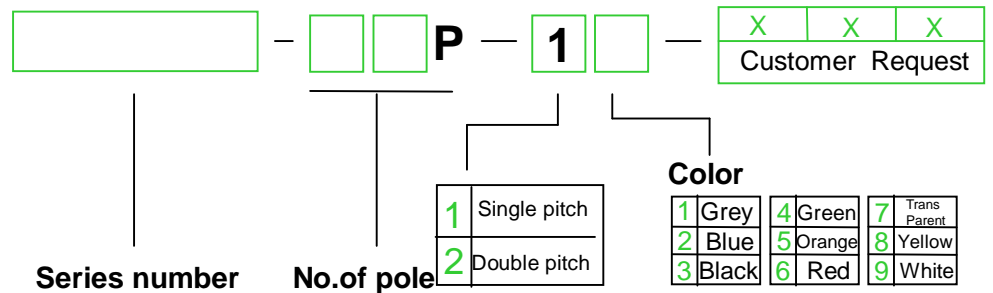
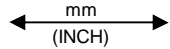

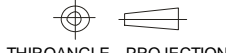
	 DEGSON ELECTRONICS CO., LTD.
	NAME DG330-5.0